

Single-axle wheels-in trailer

Operating Instructions

Part 2 - HU, HN



MACHT'S MÖGLICH

en

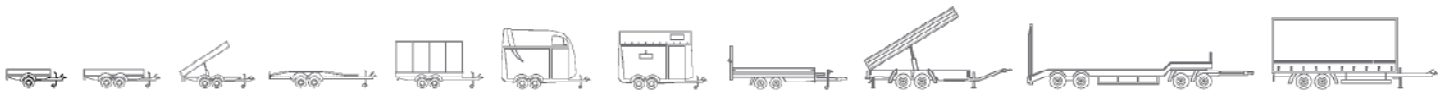

1000 Series

humbaур.com

Name and address of manufacturer:

Humbaur GmbH
Mercedesring 1
86368 Gersthofen
Germany

Tel. +49 821 24929-0
Fax +49 821 249-100

info@humbaur.com
www.humbaur.com

Name and address of dealer:

Name: _____

Address: _____

Telephone: _____



Please enter the name of your dealer.

Notes on use/Target group



PART 2 - Original - "HU, HN" Operating Instruction Manual

This "HU, HN" operating instruction manual (Part 2) is intended for you as a user of a ready-to-use trailer.

It describes detailed steps for handling the HU, HN trailers.

It contains all of the relevant details on safe operation, care/cleaning, maintenance/servicing, troubleshooting and decommissioning/disposing of the trailer.

This specific operating instruction manual (Part 2) for your trailer is on the enclosed CD. You can also download it from **www.humbaur.com under the section: Download - Operating Instructions.**

PART 1 - "Trailers up to 3.5 to" (General Points)

For all other general information on car trailers, see the operating instruction manual, "Car Trailers" (General Points - Part 1).

- PART 1 and PART 2 together form the complete documentation for your trailer, which you as the user should have at your disposal.



Read this operating instruction manual carefully and completely before using your trailer for the first time and observe all of the instructions, safety information and warnings. Comply with the steps for handling the trailer.

- Non-observance of any of the documentation can cause injuries to you and to other persons or can cause material damage.
- Non-observance may invalidate your guarantee entitlement.
- Store this operating instruction manual carefully for the entire service life of your trailer.
- It forms part of the product and also serves as a CHECK LIST for regular inspections of your trailer.
- We advise you to store the operating instruction manual in the driver's cab and to keep it at hand in case you need to consult it.
- It should be passed on to the new user/owner if you rent out or sell your trailer.





In addition, as a road user, you are obliged to observe all national regulations for driving a vehicle and trailer and to comply with your obligations as the owner of a commercial vehicle.

- This includes regularly carrying out maintenance and care tasks and periodically subjecting your trailer to an overall technical inspection.
- You must make sure that you are aware of any special stipulations that are specific to your country.

Table of Contents

Notes on use/Target group	2
1 Identification	4
1.1 Declaration of Conformity	4
2 Product Description	5
2.1 HU	5
2.2 HN	6
2.3 Optional accessories	7
2.4 Components	8
3 Intended Use	8
4 Foreseeable Misuse	8
5 General Safety Instructions	9
6 Loading and Unloading	9
6.1 Load distribution	9
6.2 Load securing	11
6.2.1 Projecting goods	12
6.3 Load securing with extension and accessories	12
6.3.1 Wood/aluminium cover	13
6.3.2 Flat cover	15
6.3.3 High cover	16
6.3.4 H-frame	16
6.4 Loading / unloading the trailer	17
7 Driving	20
8 Parking	20
9 Cleaning/Maintenance/Service	21
9.1 Care/Cleaning	21
9.2 Maintenance/Service	21
9.2.1 Tyres/Wheels	21
9.2.2 Gas strut	21
10 Troubleshooting	22
11 Decommissioning/Disposal	22

1 Identification

- ▶  Put a cross next to the type of trailer you have acquired.
- ▶  Please read the general operating instruction manual, "Car Trailers" (Part 1).

1.1 Declaration of Conformity



Humbaur GmbH hereby confirms that all relevant EU directives for the registration and safe use of trailers of the 1000 series with accessories have been complied with.

You can request a detailed EU declaration of conformity from us separately.

Product name: Single-axle wheels-in trailer

1000 Series: _____

unbraked

HU

Type 1: HU 752314

braked

HU

Type 1: HU 132314

Type 2: HU 152314

HN

Type 1: HN 132616

Type 2: HN 152616

2 Product Description

2.1 HU

The HU is equipped with anodised aluminium drop sides. All of the drop sides can be folded down and removed. The locks are recessed in the drop sides.

The 15-mm floor plate is made of multiple layers of laminated wood.

A jockey wheel on the V-drawbar is part of the standard equipment for the HU.

The HU, unbraked, with a gross weight of up to 750 kg, permits a range of applications for payloads of up to 530 kg.

The HU, braked, with a gross weight of up to 1,500 kg, permits a range of applications for payloads of up to 1,216 kg.

The load is secured with the aid of 4 tie-down brackets recessed into the profile of the trailer frame.

Optional accessories:

Side wall extension, side wall extension 700 mm, flat cover, high cover / frame construction, cover net, spare wheel, wood/aluminium cover, 2x telescopic prop stands, H-frame.

Sample illustrations



HU unbraked - side front



HU braked - side front



HU - as flat-bed (without drop sides / stanchions)



HU - side, from behind



HU - with high cover / frame



HU - with side wall extension 700 mm



HU - with side wall extension standard and flat cover



HU - with wood/aluminium cover

2.2 HN

The HN is equipped with anodised aluminium drop sides. All of the drop sides can be folded down and removed. The locks are recessed in the drop sides. The 18-mm floor plate is made of multiple layers of laminated wood. A jockey wheel on the V-drawbar is part of the standard equipment for the HN.

The HN, braked, with a gross weight of up to 1,300 kg, permits a range of applications for payloads of up to 962 kg. The HN, braked, with a gross weight of up to 1,500 kg, permits a range of applications for payloads of up to 1,152 kg.

The load is secured with the aid of 4 tie-down brackets integrated into the V-profile of the trailer frame.

Optional accessories:

Side wall extension, with flat cover, with high cover / frame construction, with cover net, with spare wheel, with 2x telescopic prop stands, with H-frame.

Sample illustrations



HN braked - side front



HN - as flat-bed (without drop sides / stanchions)



HN - side, from behind



HN / HU - with H-frame

1. H-frame (bolted)



HU - with automatic jockey wheel

1. Automatic jockey wheel



HN / HU - with telescopic spindle supports

1. Telescopic spindle support (driving position)

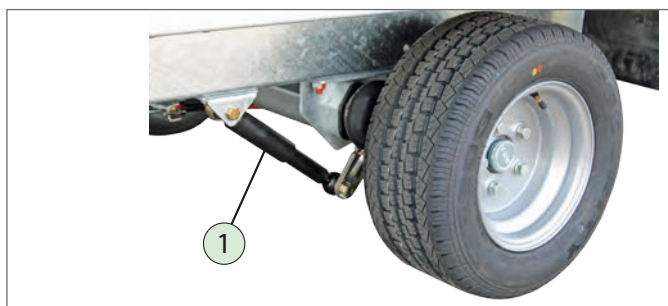

HN / HU - with shock absorbers (for 100 kph)

1. Shock absorbers

2.3 Optional accessories

HU (Model 1450)



13/7-pin adapter

HU / HN



7/13-pin adapter

HU / HN



Loose spare wheel

HU / HN



Shock absorbers

HU / HN



Telescopic prop stands

HU



Automatic jockey wheel

HU



Cover net

HU



H-frame

HU / HN



Steel grid construction

HU / HN



Flat cover / side wall extension

HU



Side wall extension 700 mm

HU



Wood/aluminium cover

HU / HN



High cover / frame

2.4 Components

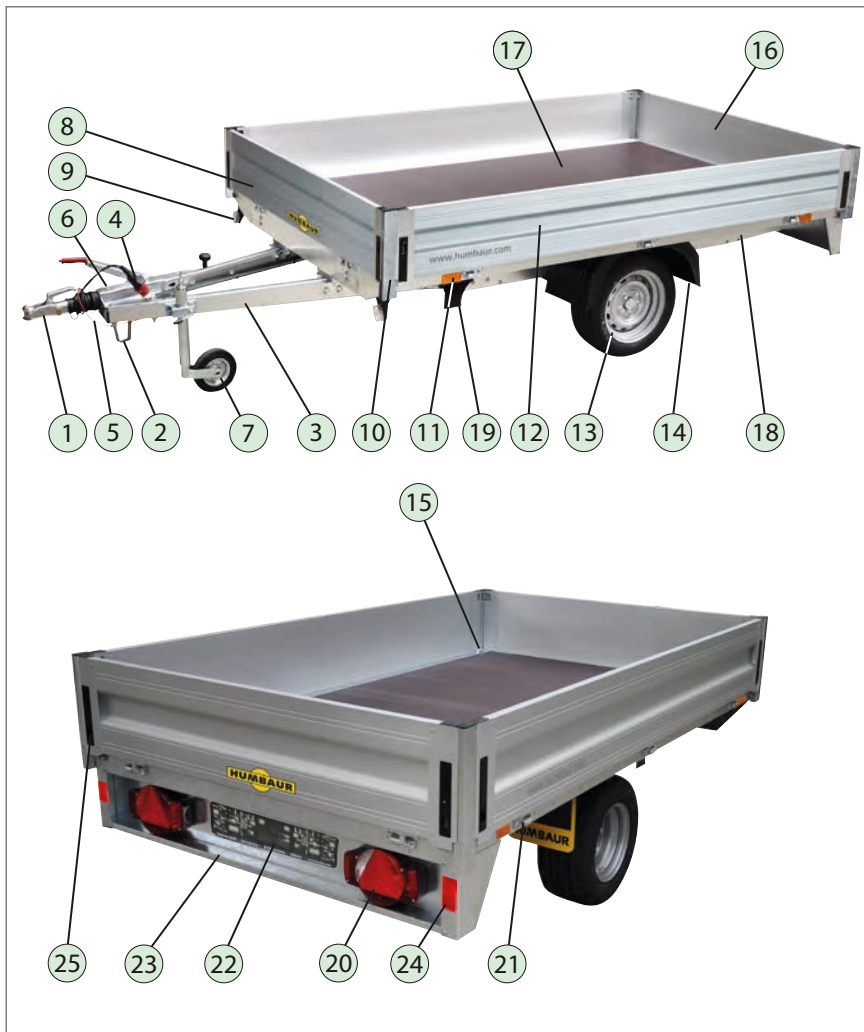

1. Coupling ball
2. Drawbar support
3. V-drawbar
4. Electric plug
5. Safety cable
6. Overrun hitch with handbrake lever, brake linkage, spring mechanism
7. Jockey wheel
8. Front drop side (facing drop side)
9. Front reflector / white reflector or front position lamp
10. Stanchion
11. Side reflector / yellow reflector
12. Lateral drop side
13. Wheel (tyre)
14. Mudguard (with / without mud flap)
15. Tie-down bracket, recessed
16. Rear drop side (back drop side)
17. Cargo bed / loading platform
18. Chassis
19. Wheel chock
20. Tail light, combined with triangular reflector, indicator, brake light, rear fog light, possibly reversing light, position lamp
21. Drop side hinge
22. Number-plate holder
23. Underride protection
24. Rear reflector / red reflector
25. Drop-side lock

Basic component (sample illustrations)



Accessories / extensions are explained separately in the part description below or in the operating instruction manual, "Car Trailers" (General Points - Part 1).

3 Intended Use

- Transporting of goods, with the exception of hazardous goods, e.g. explosive, chemical or liquid materials.
- Transporting of fixed and loose loads.
- Transporting of long loads (e.g. square timber, profiles).
- Transporting of large loads as a flat-bed variant, without drop sides and stanchions.

4 Foreseeable Misuse

- Transporting of persons or animals.
- Driving with insufficient load securing.
- Driving with the wood/aluminium cover / drop sides not locked.
- Driving as flat-bed without drop sides, but with inserted stanchions.
- Driving with side wall extensions / H-frame not bolted to stanchions.
- Non-observance of the safety instructions in the operating instruction manual, "Car Trailers" (Part 1).

5 General Safety Instructions

WARNING

Driving with folded down / unsecured drop sides / side wall extensions.

Folded down / unsecured drop sides and side wall extensions may be torn off and flung away while driving - risk of impact / crushing!

Folded down drop sides cover the vehicle lights / vehicle markings - increased accident risk!

- ▶ Before driving off, check that all drop sides / side wall extensions are closed and secured.
- ▶ Remove all drop sides / side wall extensions / stanchions when using the trailer as a flat-bed.

CAUTION



Single-axle trailer snaps open!

Single-axle trailers can snap open during loading / unloading and parking, and crush fingers / hands / feet or collide with you.

- ▶ Only park the empty trailer on the jockey wheel or the drawbar support.
- ▶ Only couple/uncouple the trailer when it is empty.
- ▶ Make use of the telescopic prop stands during loading / unloading and / or couple the trailer to the towing vehicle.



Observe the other general safety recommendations in the operating instruction manual, "Car Trailers" (General Points - Part 1).

6 Loading and Unloading



Single-axle trailers may only be loaded and unloaded with goods after being coupled to the towing vehicle.

6.1 Load distribution

CAUTION

Negative / insufficient drawbar load! Maximum permissible drawbar load exceeded!

A negative / too-low drawbar load or exceeding the maximum permissible drawbar load may result in accidents.

- ▶ Distribute the weight evenly across the trailer.
- ▶ Do not fall below the minimum drawbar load of the trailer (for trailers up to 750 kg gross weight, this is: 4% of the towed load or 25 kg).
- ▶ Do not exceed the maximum permissible drawbar load of the towing vehicle and trailer coupling.
- ▶ Where possible, make use of the maximum permissible drawbar load (see COC papers, Section 19).
- ▶  Observe the information on the maximum permissible drawbar load in your vehicle papers and the trailer coupling.
- ▶ Do not exceed the maximum permissible drawbar load of the trailer. Observe the information on the maximum permissible drawbar load in the COC papers, Section 19.

 VORSICHT		 CAUTION
Überschreitung der zul. Stützlast! Kann zu Unfällen führen-Schleudergefahr. ▶ Min. 4 % der Anhängerlast einhalten, mehr als 25 kg nicht notwendig. ▶ Zul. Stützlast des Zugfahrzeugs beachten!	E20.00402	Exceeding the permissible vertical load! Can lead to accidents-risk of skidding. ▶ Min. 4 % of the trailer load to comply, more than 25 kg are not necessary. ▶ Perm. Note vertical load of the vehicle!



Avoid turning your load into a projectile.

- The static force [m] is used as a point of departure for dimensioning the means to secure the load.
- As the speed increases, so does the inertia / centrifugal force of the load.
- Sample calculation:
[m] = 1 kg ~ 1 daN static force
[v] = acceleration speed of mass
[E_{kin}] Formula: $E_{kin} = \frac{m \cdot v^2}{2}$

at 0 kph = 1 kg kinetic energy
at 40 kph = ~ 600 kg kinetic energy
at 80 kph = ~ 2,400 kg kinetic energy

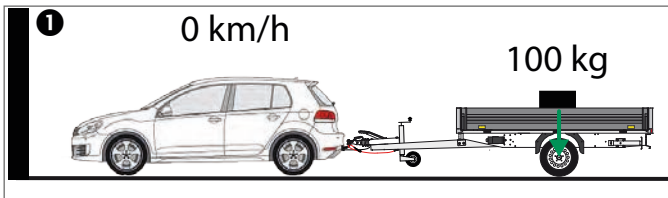

Vehicle standing still

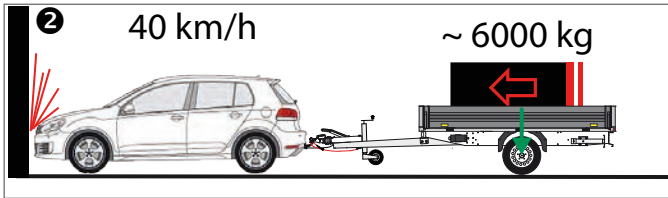

Fully braked at 40 km/h

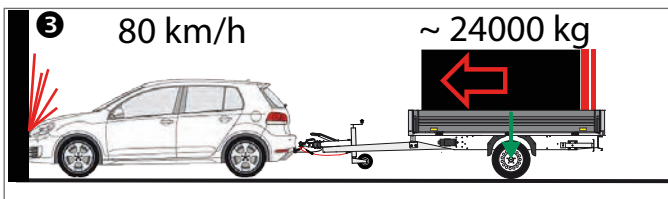

Forces acting on trailer when fully braked

Conclusion:

- When doubling the speed, the kinetic energy that can be released by the unsecured load when the trailer is fully braked increases four-fold.
- Wrongly / poorly distributing the load results in serious accidents, even at low speeds.
- Overloading the trailer means intentionally producing a risk, which can result in the trailer skidding and meeting with a serious accident even after a minor steering manoeuvre, a bump in the road or a gust of wind!

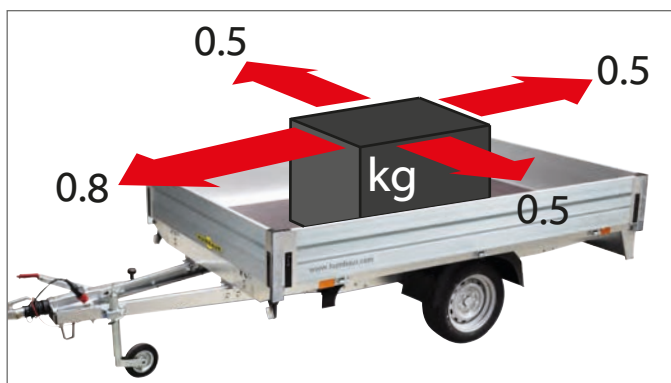

Forces to be secured against skidding

- **Securing at the front** (when fully braked)
0.8 or 80% of the static force:
e.g. 1,000 kg must be secured with 800 daN
- **Securing at the side / rear**
(when swerving / starting / driving round bends)
0.5 or 50% of the static force:
e.g. 1,000 kg must be secured with 500 daN

- ▶ Counteract the potential release of forces by:
 - Correct load distribution
 - Using adequate means to secure the load in accordance with its weight (tie-down equipment, tie-down points)
 - Using anti-skid materials (anti-slip mats)
 - Correctly attaching the load, e.g. with a cover net, tarpaulin or cover
 - Adapted speed
 - Additional accessories (H-frame, side wall extensions)

Correct load distribution

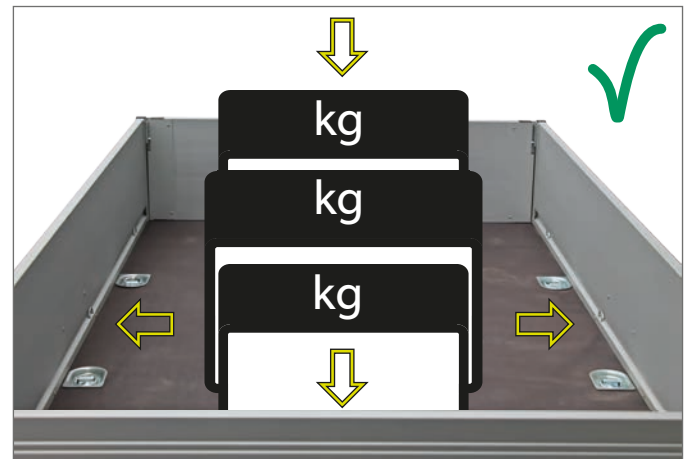

Load correctly distributed

- Centrally aligned (balanced load)
- Heaviest load positioned above axle
- Form-fitted at front and rear

Incorrect load distribution



Load incorrectly distributed



Load incorrectly distributed

- Eccentric alignment (one-sided load)
- Too far forward or too far back
- Load not form-fitted
- Proper tie-down not possible

6.2 Load securing

- ▶ Preferably secure the load as a combination of form-fitting and force-fitting:

- Force-fitted by: direct tie-down of the load.
- Form-fitted by: supporting the various components of the load against each other, against the drop sides and against the cargo-bed extensions, without spaces in-between.



Loose loads not secured



Secured with cover net

1. Cover net



Secured with flat cover

2. Flat cover



Secured with form-fitting and tie-down



Secured with tie-down (on flat-bed)

3. Lashing strap
4. Edge protector / edge slider
5. Securing the bottom of the load (squared timbers, pallets, anti-slip mats)
6. Force-fitted loading unit (strapping)

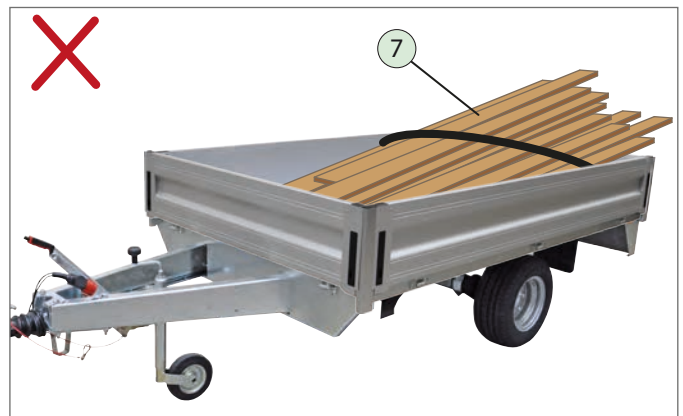

Wrongly secured / loaded

7. Long load, supported on rear drop side

6.2.1 Projecting goods



Goods that project over the cargo bed or drop sides must be marked in accordance with Section 22 of the StVO (German Road Traffic Act).

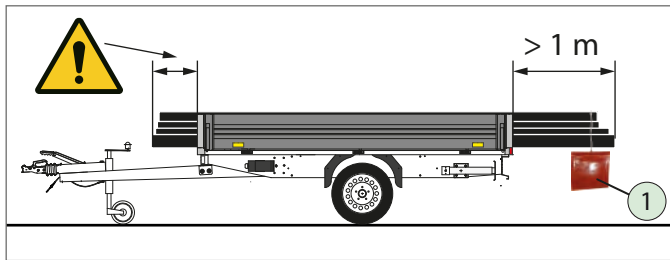

Marking goods

1. Sign / flag (30 cm x 30 cm) or cylindrical body (ø 35 cm x 30 cm), bright red
 - ▶ Check that your load does not exceed the maximum permissible values according to Section 22, "Goods", of the StVO.
 - ▶ Mark any projecting goods.
 - Make use of the prescribed means for doing so.
 - ▶ Do not load the goods too far forward.
 - The required swerving range for driving around bends must remain open!



WARNING

Restricted swerving range - risk of collision!

Supporting the load on the front drop side and allowing it to project forwards reduces the swerving range when driving around bends - accident risk!

- ▶ Remove the front and rear drop side.
- ▶ Before driving off, check that the restricted swerving range will allow your towing vehicle to drive around bends.
- ▶ Adjust the distribution of the load (towards the middle of the drawbar) if necessary.

6.3 Load securing with extension and accessories

Tying down goods

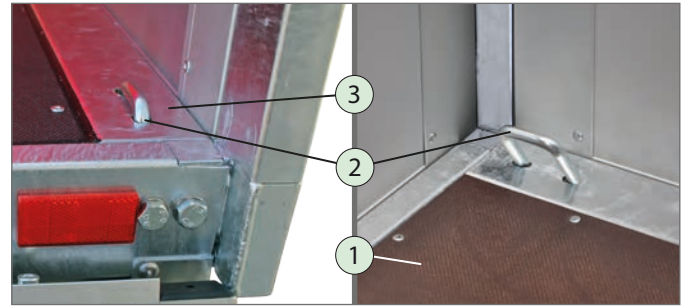

HU - tie-down points

1. Loading platform
2. Tie-down brackets, recessed
3. Frame profile

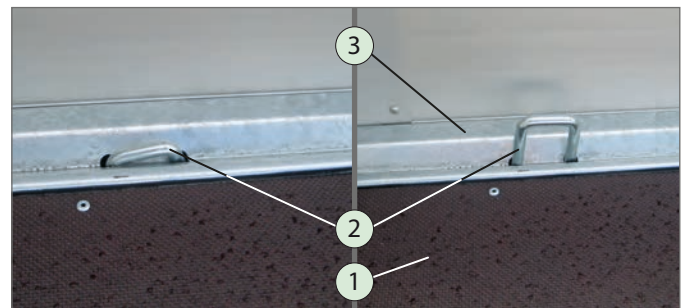

HN - tie-down points

1. Loading platform
2. Tie-down brackets, recessed
3. V-frame profile

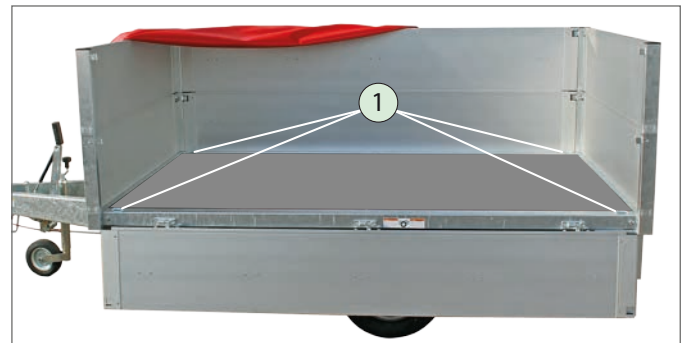

Tie-down points - arrangement on cargo bed

1. Tie-down points (HU / HN)
 - ▶ Tie down the load.
 - Do not exceed the maximum permissible tie-down forces per tie-down point.
 - ▶ Take note of the sticker providing information about the maximum tie-down forces on the trailer.



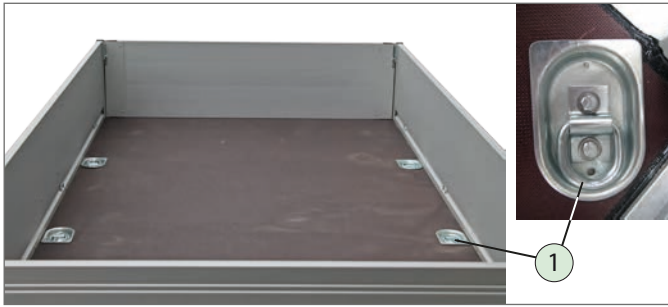

Optional / additional tie-down points

1. Tie-down ring recessed in tie-down groove in loading platform

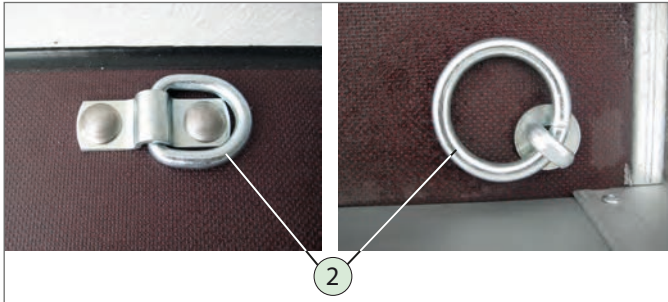

Optional / additional tie-down points

2. Folding rings on the loading platform

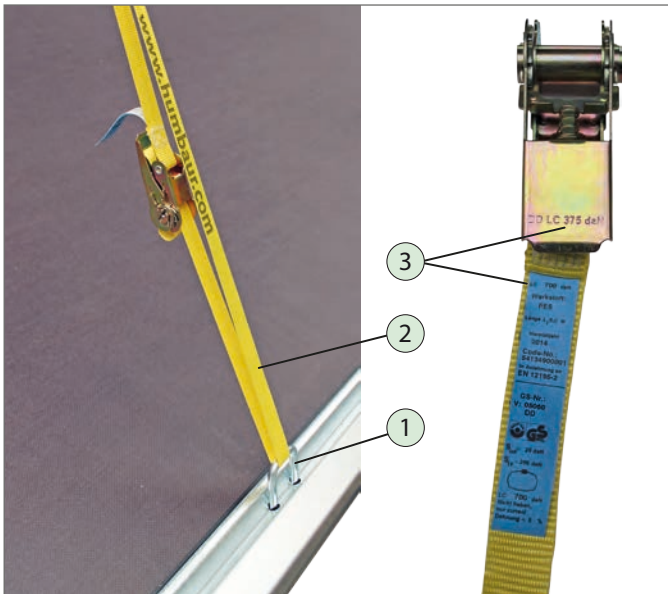

Tie-down of load

1. Tie-down point
 2. Tie-down equipment (tension belt)
 3. Tie-down force information
- ▶ Adhere to the maximum tie-down force for the tie-down equipment (e.g. tension belts).

6.3.1 Wood/aluminium cover

Functional explanation

- The wood/aluminium cover is used for the protected transport of sensitive goods.
- The wood/aluminium cover can be locked with a key and thus protects your goods against theft.
- The loading volume is increased by the internal height of the wood/aluminium cover, i.e. by 185 mm.
- The wood/aluminium cover is supported by gas struts for easier opening. The gas struts keep the cover in an open position.
- The wood/aluminium cover is available for the HU type. It has been specifically adapted to the trailer size.

⚠ WARNING



Driving with cover open / unlocked!

The cover can spring open while driving and be torn off / deformed. The goods may be flung off. The trailer may start to skid and be uncoupled from the towing vehicle.

- ▶ Do not drive with the cover open / half-open.
- ▶ Before driving off, check that the cover is properly closed and locked.

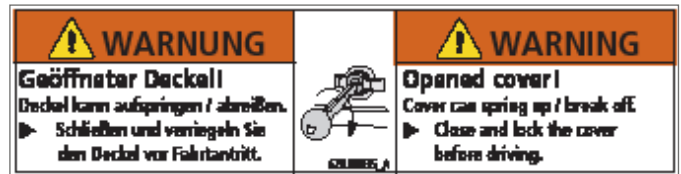

Presence in the trailer with the cover closed!

Risk of suffocation due to lack of oxygen in loading area.

- ▶ Avoid being in the closed trailer.
- ▶ Do not transport any live animals.
- ▶ Before closing the cover, check that there are no persons / animals in the trailer.

⚠ CAUTION



Operating the cover!

You may catch your hands/body in the cover or bump your head while folding the cover down.

- ▶ Operate the cover carefully.
 - Do not allow the cover to fall shut on its own.
- ▶ Use the handle to operate the cover - do not reach over the closing edge or into the transmission linkage.
- ▶ Use the pull strap to close the cover and hold it firmly by the handle.

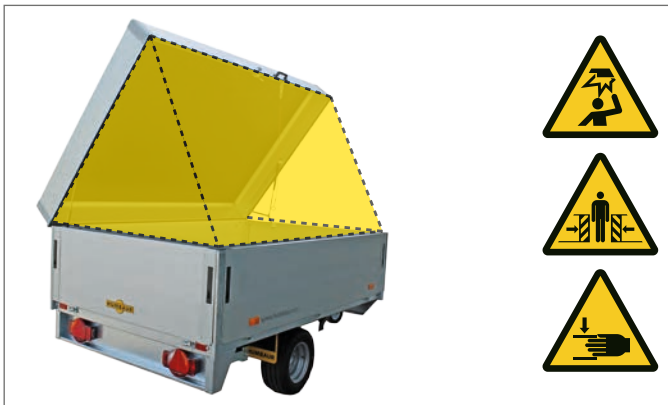

Risk areas

CAUTION



Worn gas strut!

Where a gas strut is leaking / worn, the cover may fold down on its own and hit / bump you.

- ▶ When operating the cover, ensure that it does not fall down by itself.
- ▶ Have any faulty / worn gas struts replaced immediately by a specialised workshop.

NOTICE

Overload on cover / rail!

The cover / rail may become deformed or break.

- ▶ Limit the weight on the cover / rail to a maximum of 60 kg.
- ▶ Do not climb onto the cover / rail.

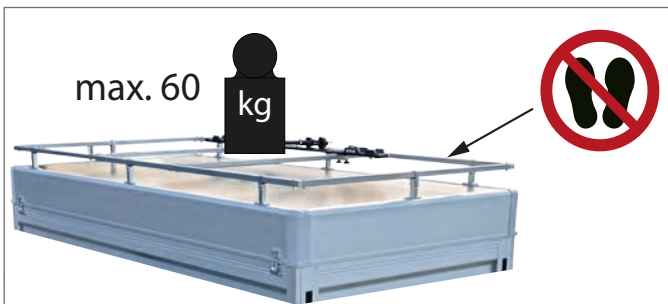

Opening the foldable front drop side!

The transmission linkage for the gas strut is attached to the front drop side. Opening the front drop side results in deformation of the cover. It may fall down.

- ▶ Never open the front drop side.
- ▶ Do not remove the lock securing screws.

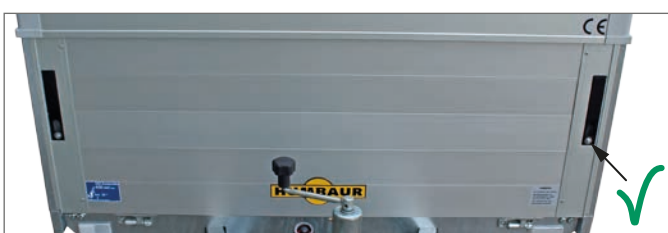

Operating the cover

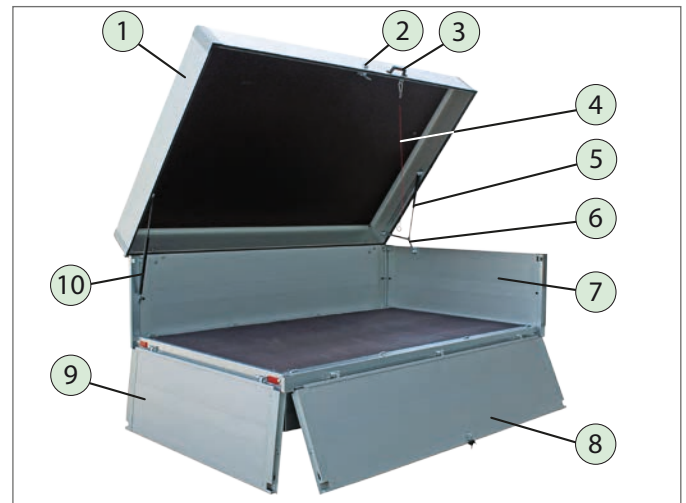

Wood/aluminium cover with rail

1. Cover
2. Lock
3. Handle
4. Pull strap
5. Gas strut (front drop side)
6. Transmission linkage
7. Front drop side, fixed
8. Lateral drop side, foldable
9. Gas strut (rear drop side)
10. Rear drop side, foldable

Unlocking

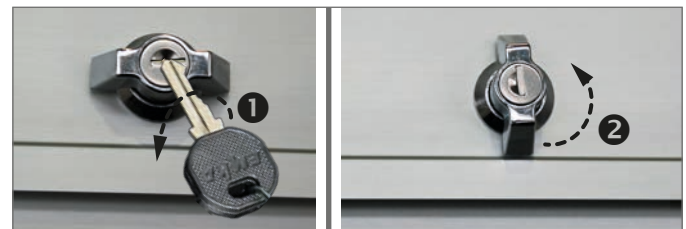

Lock unlocked

- ▶ Use the key to open the lock.
- ▶ Turn the lock into a vertical position.
 - The cover is now unlocked.

Opening



Cover open

- ▶ Take hold of the handle and lift the cover.
 - The gas struts support the opening of the cover and hold it open in its final position.

Closing

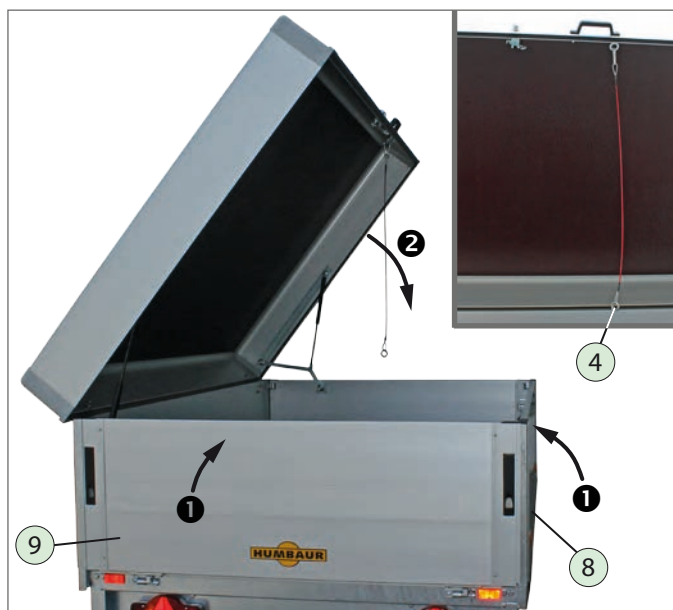

Closing the cover

- ▶ First close the rear and side drop sides.
- ▶ Take hold of the pull strap and pull the cover downwards until you can reach the handle.
- ▶ Push the cover completely shut.
 - Ensure that the lock is in an open position.

Locking

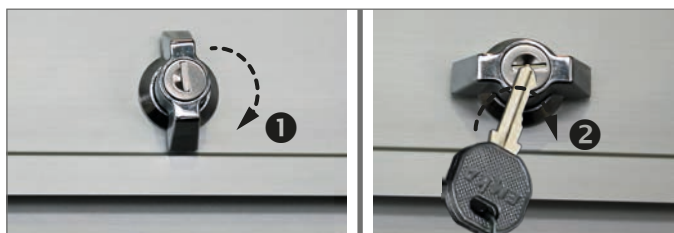

Lock locked

- ▶ Turn the lock into a horizontal position.
 - The cover is closed.
- ▶ Use the key to lock the lock.
 - The cover is locked.

 The goods must be secured, even in a closed trailer.

- ▶ Secure the goods within the loading area.

6.3.2 Flat cover

 HN / HU trailers with a flat cover have an additional lateral bracing. The lateral bracing supports the centre of the flat cover. Any water / load accumulating on the flat cover may cause it to sag and damage it.

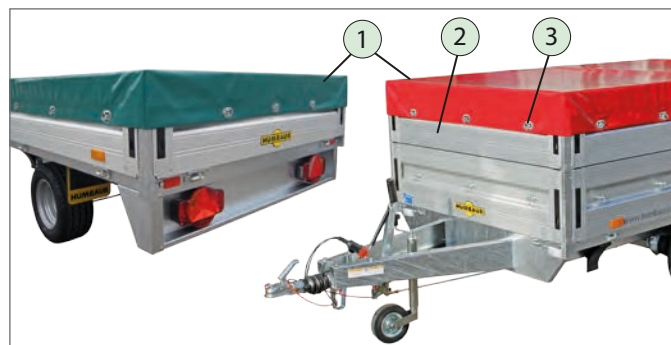

Load securing with a flat cover

1. Flat cover
2. Side wall extension
3. Staple



Operating the flat cover

4. Lateral bracing, fitted
 - ▶ Fit the lateral bracing to the drop sides at the centre of the side drop sides.
 - Ensure that the lateral bracing is arranged at a 90° angle to the side drop side.

 Instructions for operating the flat cover are given in the operating instruction manual, "Car Trailers" (General Points - Part 1).

The flat cover / high cover can be secured against unauthorised opening using a fastening rope.

- ▶ Guide the fastening rope through all the closed staples and tie the ends of the rope together.
 - Where necessary, use a lock such as a shackle lock to secure the ends.

6.3.3 High cover



The HN / HU trailers are attached to the stanchions with a hoop frame and high cover and secured to the drop sides on all sides. The high cover can be opened at the back and sides for easy loading / unloading. The drop sides can be folded down for loading / unloading.



Load securing with high cover / frame

1. High cover
2. Belt
3. Buckle
4. Staple



Securing the high cover / flat cover

1. Fastening rope
2. Rope termination
3. Lock (e.g. shackle lock)
4. Rope ends for lead seal



Instructions for operating the high cover / frame are given in the operating instruction manual, "Car Trailers" (General Points - Part 1).

6.3.4 H-frame



The HN / HU trailers are attached to the front stanchions with an H-frame and secured. The H-frame is used to transport and secure long loads. Long loads must be secured as individual loading units. It is not permitted to drive with loose loads on the H-frame. The loads must be secured and tied down to the trailer or H-frame.

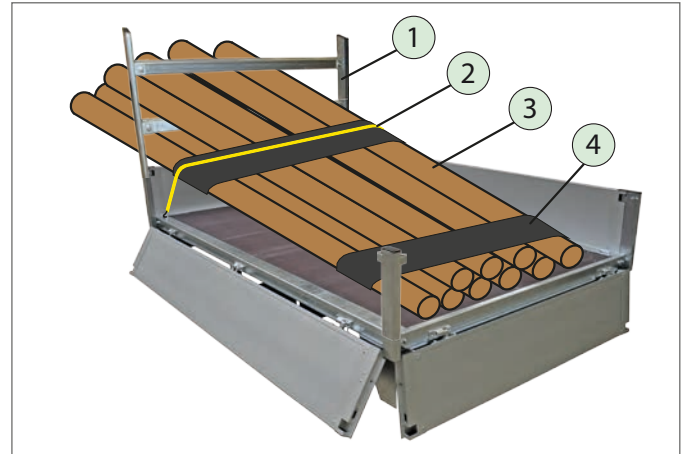

Load securing with H-frame

1. H-frame
2. Lashing strap
3. Loading unit (long pipes, rods, planks)
4. Securing the loading unit

- ▶ Use tension belts to tie-down the load to the H-frame and directly to the tie-down points on the loading platform.
 - Ensure that the load cannot slide and is safely positioned / distributed.



Instructions for mounting / removing the H-frame are given in the operating instruction manual, "Car Trailers" (General Points - Part 1).

6.4 Loading / unloading the trailer



Make sure that the trailer is secured so that it cannot roll away.

! WARNING		! WARNING
Unzureichende Beleuchtung beim Be- und Entladen! Erhöhte Unfallgefahr. ► Sichern Sie den Anhänger mit zusätzlichen Signaleinrichtungen.		Inadequate lighting during loading and unloading! Increased risk of accidents. ► Secure the trailer with additional signalling devices.

- Make sure that road traffic safety is not impaired when loading and unloading the trailer.
- If necessary, use additional signalling devices, e.g. signs, barriers.

6.4.1 Drop sides / Side wall extensions

! WARNING

Driving as flat-bed with stanchions inserted!

The stanchions may be flung out while driving - accident risk!
Someone may be injured - impact risk!

- Remove all stanchions before starting to drive.
- Remove all drop sides before starting to drive.

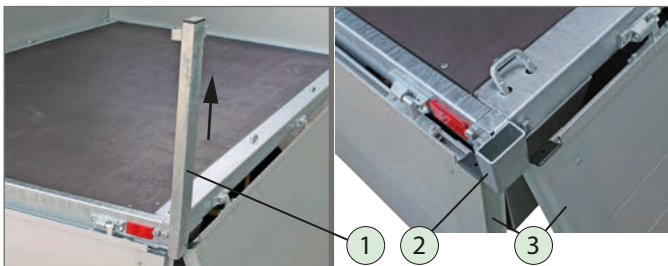

Removing stanchions

1. Stanchion
2. Stanchion bracket
3. Drop sides



Driving as flat-bed (drop sides / stanchions removed)

NOTICE

Opening the main drop side while the side wall extension is in place!

The side wall extensions are mounted on the main drop sides. Following the wrong sequence when opening the drop sides may result in damage to them.

- Remove the side wall extension before opening the main drop side.

Opening



Unlock locks

1. Tarpaulin
2. Covered lock
3. Side wall extension

- Unlock the recessed locks on both sides.
- While doing so, hold the drop side / side wall extension firmly with one hand.



Side wall extension removed

4. Stanchions
5. Rear drop side, closed

- Carefully remove the side wall extension.
- Store it where it is safe from damage.



Rear drop side folded down

6. Rear drop side, folded down

- Carefully fold down the drop side in a controlled manner.



Drop sides folded down / stanchions removed

1. Stanchions, removed
2. Lateral drop side, folded down
3. Rear drop side, folded down

- ▶ The drop sides can be folded down, depending on the loading / unloading process.
- ▶ To facilitate loading / unloading and to prevent damage, the stanchions may be removed.

Closing



Stanchions inserted / close drop sides

1. Locking lugs on stanchions
2. Main drop sides

- ▶ **1** Insert all stanchions into the stanchion brackets.
 - Ensure that the locking lugs point in the direction of the cargo bed.
- ▶ **2** Fold up the main drop sides.
 - Ensure that the locks are open.
- ▶ Lock all drop-side locks.
 - While doing so, hold the drop sides firmly with one hand.
 - Ensure that they correctly engage with the locking lugs of the stanchions.

Mount side wall extensions



Mount / lock side wall extension

1. Main drop side
2. Side wall extension
3. Lock

- ▶ Mount the side wall extension on the locked main drop side.
 - Ensure that the lug on the lower edge of the side wall extension points inwards towards the cargo bed and that the locks point outwards.
- ▶ Close the locks one by one.
 - While doing so, hold the side wall extension with one hand.



Side wall extension inserted / locked

4. Lugs on the lower edge of the side wall extension

Remove the main drop sides

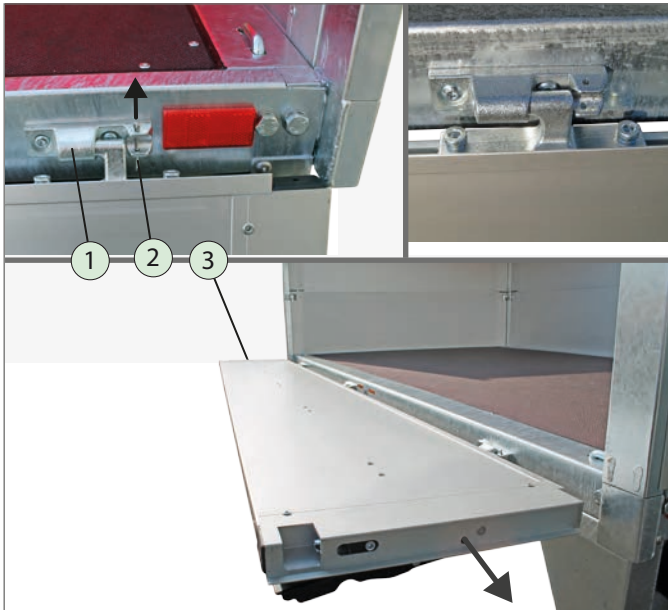

Remove the main drop side

1. Drop side hinge
2. Securing split pin
3. Main drop side

- ▶ Remove the securing split pin from the drop side hinge.
- ▶ Fold the drop side into a horizontal position.
- ▶ Carefully pull out the drop side in the direction that is now unobstructed.
- ▶ Put the drop side where it is safe from damage.

Mounting

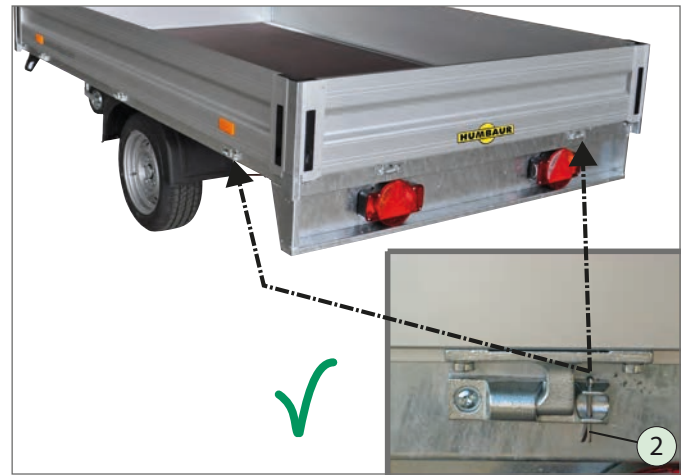

Mount / secure the main drop side

- ▶ Slide the drop side onto its hinges in a horizontal position.
- ▶ Push the securing split pin into one of the hinges and open the securing split pin slightly.
- ▶ Fold up the drop side.
Ensure that the locks are open.
- ▶ Lock the locks on both sides.

6.4.2 Telescopic prop stands



HN / HU trailers can be optionally equipped with swivelling telescopic prop stands. The supports may only be retrofitted at the attachment points provided. The frame already has drill holes for fitting the supports.



Read and observe the assembly instructions.



Telescopic prop stands, swivelling

1. Chassis
2. Telescopic prop stand

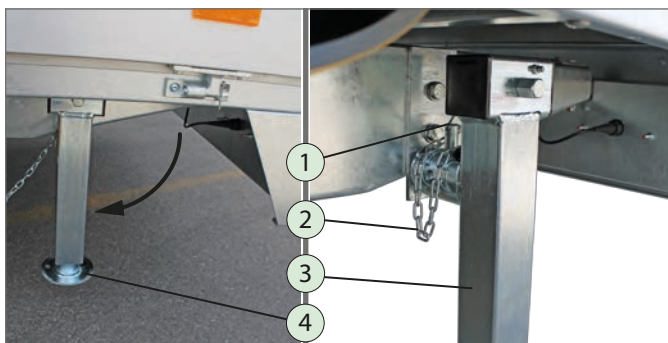

Support position for telescopic prop stands

1. Plug bolt, inserted
2. Safety chain
3. Support body
4. Adjustable support



Instructions for operating the telescopic prop stands are given in the operating instruction manual, "Car Trailers" (General Points - Part 1).

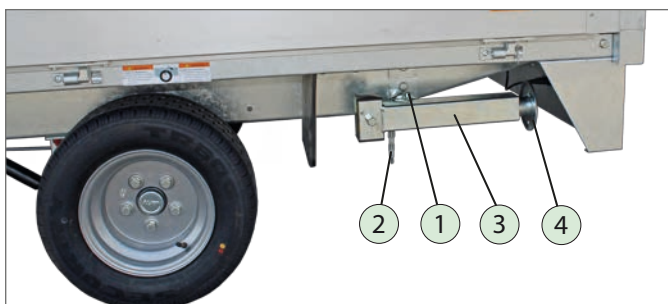

Driving position of telescopic prop stands

- ▶ Secure the telescopic prop stands in the supporting and driving position, using the plug bolt.
 - The plug bolt must be pushed through the free hole from the top.

7 Driving



Before driving off, make sure that the maximum permissible loads (load capacity and drawbar load) are not exceeded.



Observe the maximum permissible towing load and drawbar load of your towing vehicle and the trailer coupling.

- ▶ Where required, check the weight information for the goods to be loaded.
- ▶ Carry out a departure check (see operating instruction manual, "Car Trailers" (General Points - Part 1))

8 Parking



Observe the general safety and warning instructions on parking your trailer safely in the operating instruction manual, "Car Trailers" (General Points - Part 1).

9 Cleaning/Maintenance/Serviceing

9.1 Care/Cleaning



Observe the safety instructions and instructions for general cleaning/care of trailers in the operating instruction manual, "Car Trailers" (General Points - Part 1).

9.2 Maintenance/Serviceing



Maintenance instructions are given in the operating instruction manual, "Car Trailers" (General Points - Part 1).
Further specific maintenance instructions may be found here.

9.2.1 Tyres/Wheels

- ▶ Check the tyre pressure on all wheels on a regular basis and before long journeys.
(see the table: "Maintenance instructions" in the operating instruction manual, "Car Trailers" (General Points - Part 1))

9.2.2 Gas strut



WARNING

Remove gas struts!

The gas struts are subject to high pressure!
Improper fitting / removal may result in injury to persons
- impact/collision risk!

- ▶ Observe the safety warnings on the gas struts.
- ▶ Take note of the instructions provided by the gas-strut manufacturer.
- ▶ Have worn / defective gas struts replaced by trained staff only.



The working range of the gas struts is:

- 25°C to + 60°C.

Service life, functionality and safety depend largely on ensuring that the gas struts are serviced and maintained regularly.

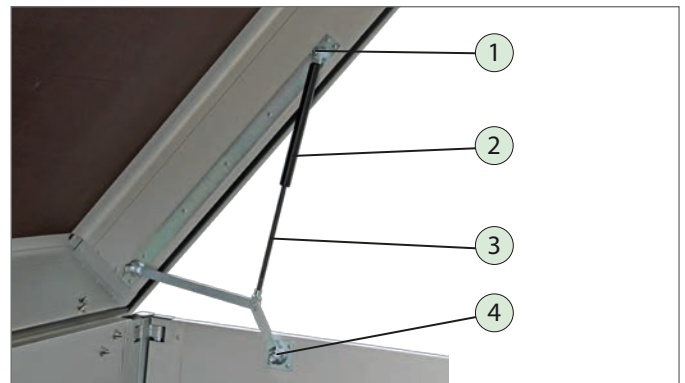

Maintaining gas struts

1. Attachment
2. Gas strut (body)
3. Piston rod
4. Rod mounting

- ▶ Secure the wood/aluminium cover against falling when fitting / removing the gas strut.



During spraying, do not aim the water jet directly at the gas struts.

- ▶ Keep films and paper packaging away (electrostatic charging is possible).
- ▶ Do not scratch or paint the piston rod or treat it with aggressive media (abrasives).
- ▶ Grease the piston rod.

10 Troubleshooting



For causes of faults and rectification measures, see the operating instruction manual, "Car Trailers" (General Points - Part 1).

11 Decommissioning/Disposal



Observe the safety instructions for decommissioning / disposal of trailers in the operating instruction manual, "Car Trailers" (General Points - Part 1).

11.1 Decommissioning the trailer

- ▶ Secure your trailer against unauthorised use by third parties, e.g. using wheel clamps.
- ▶ Park your trailer so that it cannot cause any further hazards for third parties, e.g. by tipping over, rolling away, or causing a traffic obstruction.

11.2 Disposal

- ▶ Take the individual parts or the entire trailer to a car/vehicle recycling facility. The specialists at the car/vehicle recycling facility will dispose of the individual components in the proper manner .



No liability is accepted for errors or printing errors.
All illustrations are representative.
Deviations and modifications are subject to the model type.
Subject to technical modifications.
Copying prohibited.
Printed in Germany.
Version 2019/01